

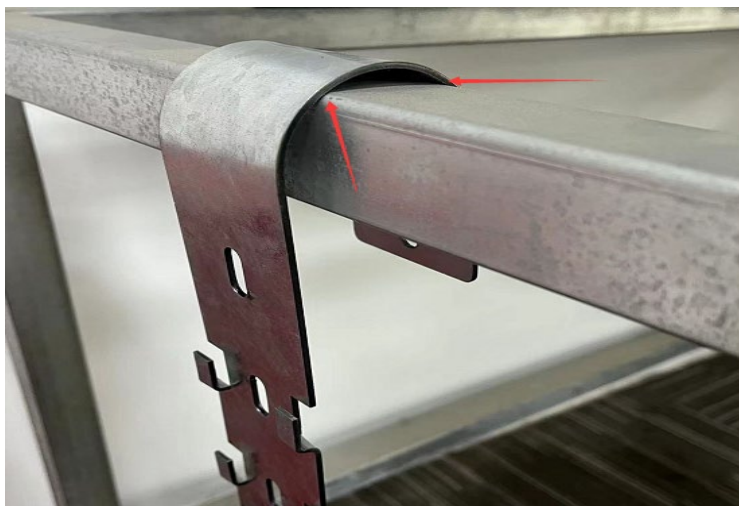

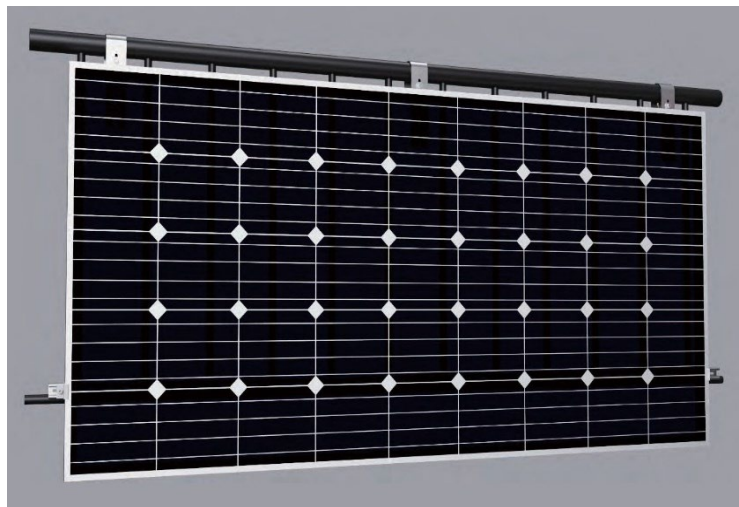

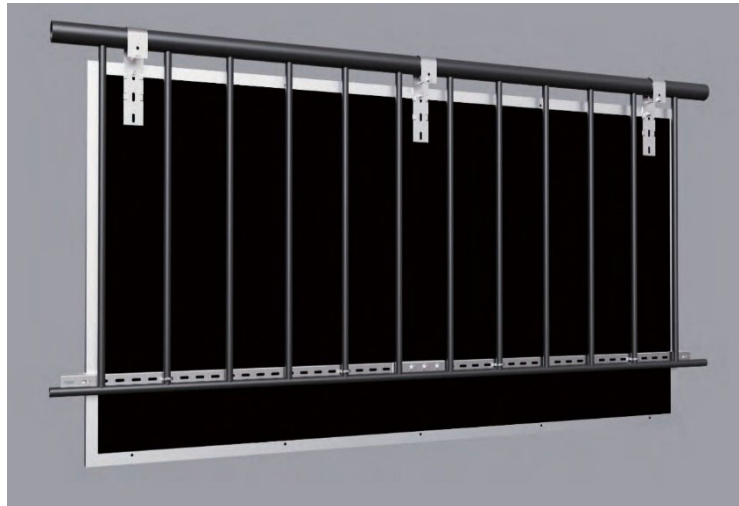



Balkon-Solarmodule-Montagehalterung

Montageanleitung

Geeignet für Runde und Eckige Geländer



Inhalt

Artikel	Foto	Menge	Material
Montageschiene	 (A)	2	AZM
Geländer-Haken	 (B)	3	SUS304
Rohrschellen	 (C)	4	AZM
Schienenverbinder	 (D)	1	SUS304
Montageset A	 1x SUS304 M8*80 Schraube 1x SUS304 Federscheibe 2x SUS304 große Unterlegscheibe 1x SUS304 Nylon-Sicherungsmutter (E)	3	SUS304
Montageset B	 1x SUS304 M8*25 Schraube 1x SUS304 Federscheibe 2x SUS304 große Unterlegscheibe 1x SUS304 Nylon-Sicherungsmutter (F)	3	SUS304
Endklemme (mit 30-35mm)	 (G)	2	AL6005+ SUS304

Montageanleitung

Schritt 1: Verbinden Sie zwei Montageschienen (A) mithilfe von Schienenverbinder (D). Achten Sie drauf, dass je 2 Sechskantschrauben mit Muttern an jeder Montageschiene befestigt sind. (Tipp: Wenn die Länge des Panels 5 cm kürzer als die einzelne Montageschiene ist, dann ignorieren Sie bitte diesen Schritt)

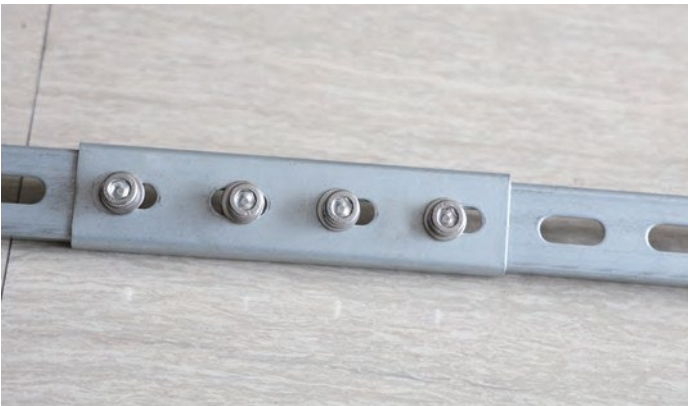
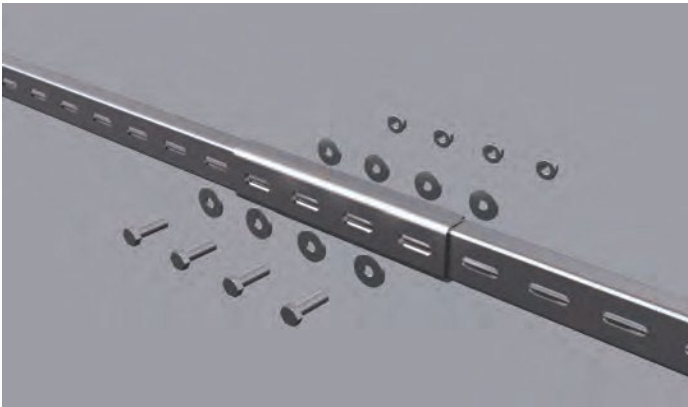

Schritt 2: Platzieren Sie die Montageschienen (A) an der Unterseite des Balkongeländers und befestigen Sie diese mithilfe von (4x) Rohrschellen .



Schritt 3: Installieren Sie die 3 Geländer-Haken (B) in einem gleichmäßigen Abstand am Rahmen des Moduls mithilfe des Montagesets B (F).

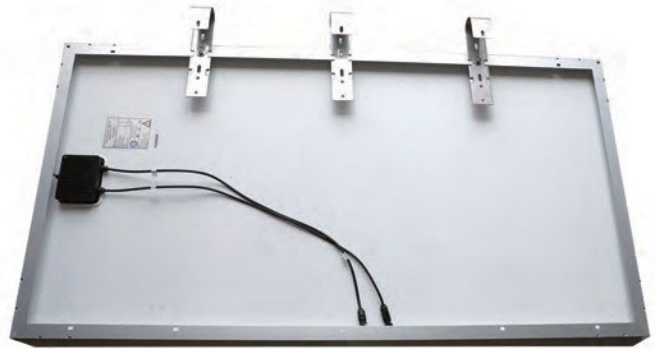

Schritt 4: Platzieren Sie die Geländer-Haken am Handlauf des Balkons und stellen Sie dabei sicher, dass das Solarpanel nach außen zeigt. Verwenden Sie das Montageset A (E), um die Geländer-Haken aus dem Handlauf herauszuhalten. (Tipp: Tragen Sie das Solarpanel zu zweit und stellen Sie sicher, dass alle Befestigungselemente ordnungsgemäß angebracht worden sind.)

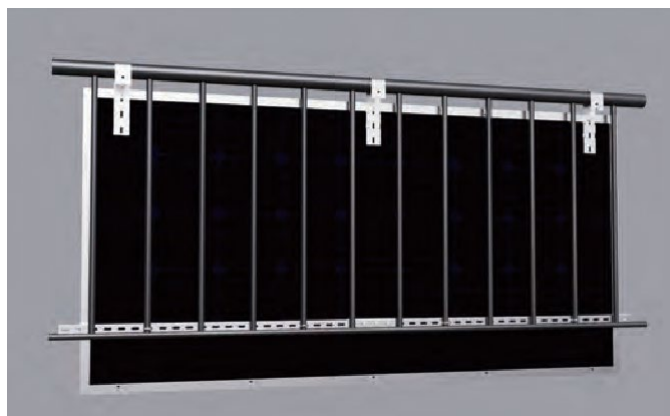

Schritt 5: Setzen Sie die Endklemmen (G) in die Nut der Montageschiene (A) ein, befestigen Sie sie am Solarpanel und verriegeln Sie den Rahmen des Solarpanels fest mit der Montageschiene.

(Tipp 1: Verwenden Sie die richtige Endklemme, um die Rahmenhöhe des Solarmoduls zu messen.)

(Tipp 2: Achten Sie darauf, dass beide Seiten des Paneels fest verriegelt werden.)



Schritt 6: Überprüfen Sie zu guter Letzt alle Schrauben und Muttern und stellen Sie sicher, dass alle Befestigungen fest sitzen, sodass das Solarmodul sich weder nach links, noch nach rechts bewegt.

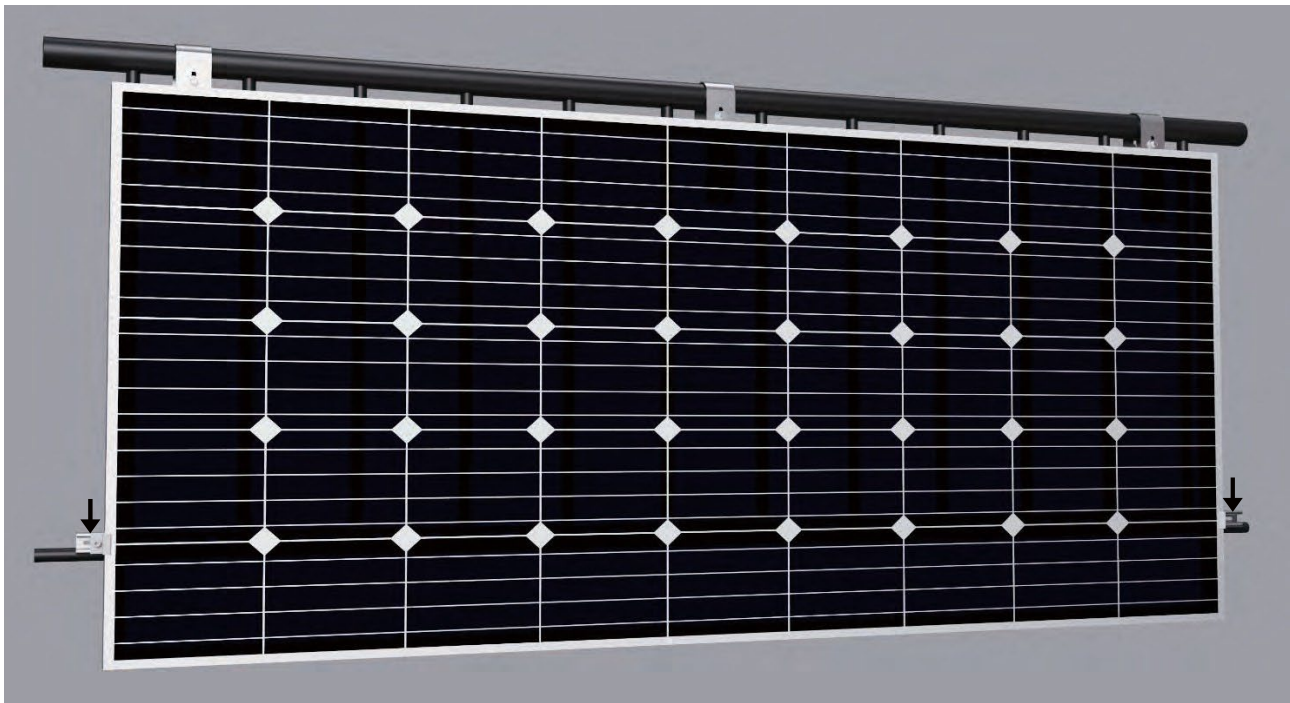









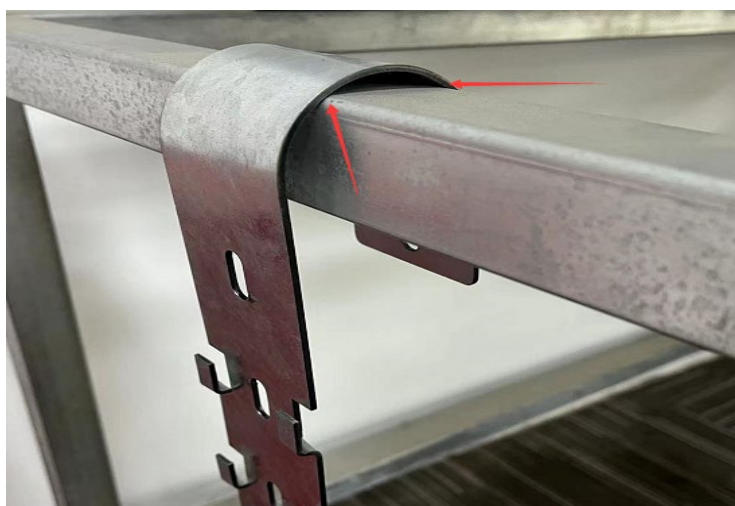
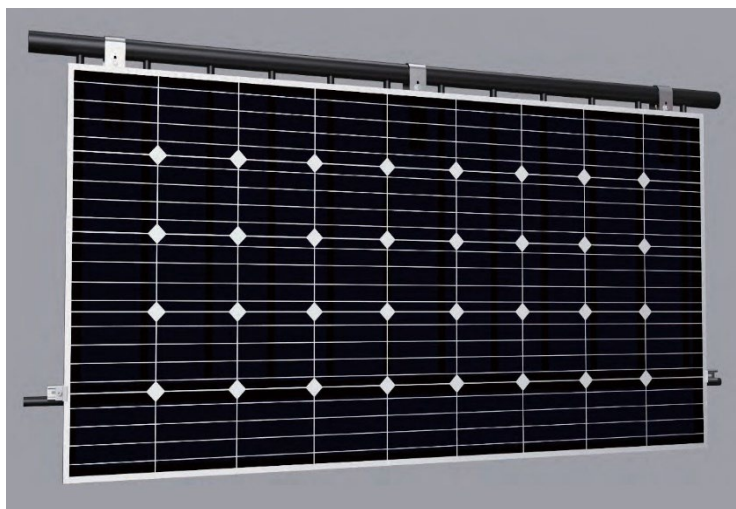
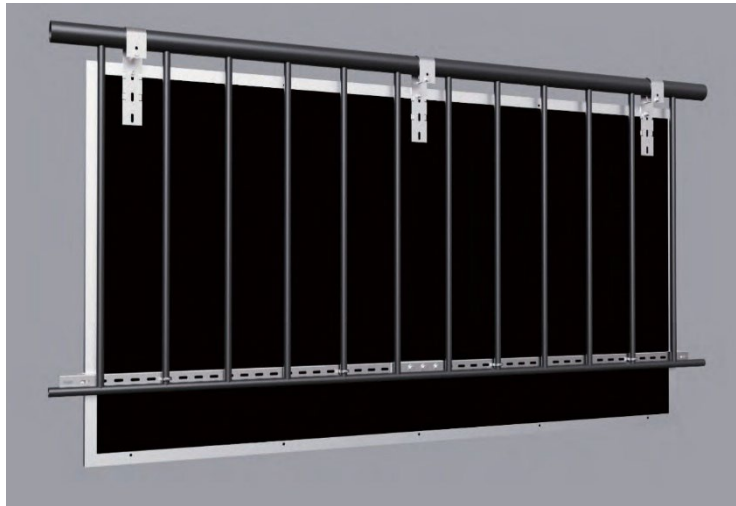

Balcony Solar Panel Mounting Bracket

Installation Guide

For round and square railings



Package Contents

Item	Photo	QTY	Material
Mounting Rail	 <p style="text-align: right;">(A)</p>	2	AZM
Solar Hook	 <p style="text-align: right;">(B)</p>	3	SUS304
Rail Clamps	 <p style="text-align: right;">(C)</p>	4	AZM
Rail Joint	 <p style="text-align: right;">(D)</p>	1	SUS304
Solar Hook Fastener (to handrail)	 <p style="text-align: right;">(E)</p> <p style="text-align: center;">1x SUS304 M8*80 bolt 1x SUS304 Spring washer 2x SUS304 Big flat washer 1x SUS304 Nylon lock nut</p>	3	SUS304
Solar Hook Fastener (to solar panel frame)	 <p style="text-align: right;">(F)</p> <p style="text-align: center;">1x SUS304 M8*25 bolt 1x SUS304 Spring washer 2x SUS304 Big flat washer 1x SUS304 Nylon lock nut</p>	3	SUS304
End Clamp (for 30-35mm) Frame	 <p style="text-align: right;">(G)</p>	2	AL6005+ SUS304

Installation Instruction

Step 1: Connect two Mounting Rails(A) into one by Rail Joint(D); Ensure 2 of HEX screw & Nuts fixed on the each Mounting Rails.

(Tip: If the length of panel is 5cm shorter than the single mounting rails, please ignore this step)

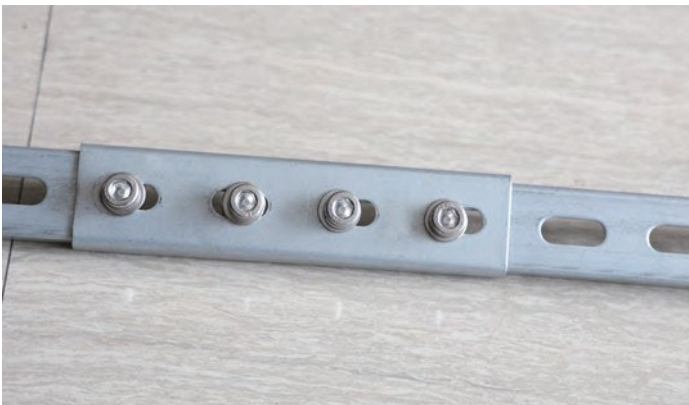
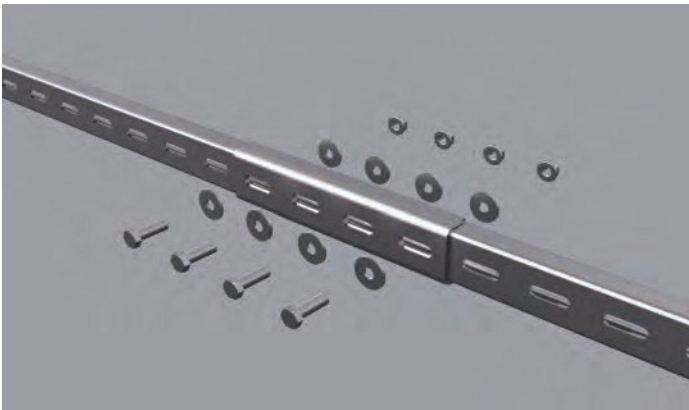

Step 2: Place the Mounting Rail(A) close to the bottom of Balcony rails;
Fasten the mounting rail to balcony rails by (4x) Rail Clamps (C).

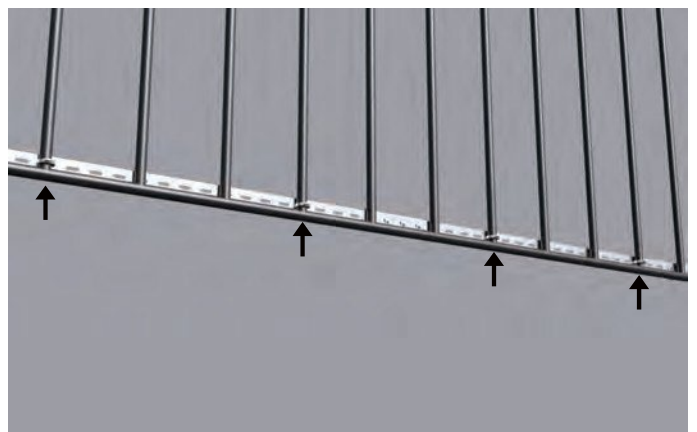

Step 3: Install the 3pcs solar hook (B) evenly to the frame of the solar panel, using solar hook fastener (F).

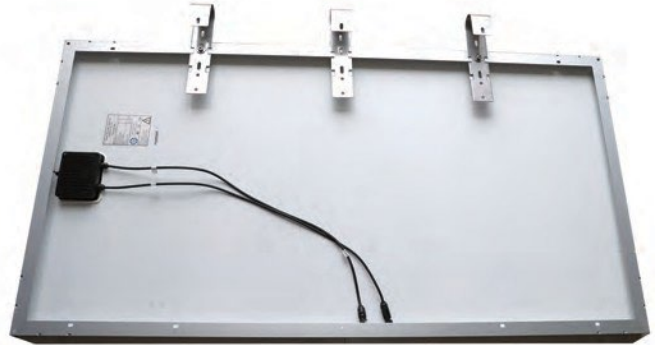

Step 4: Place the solar hook onto the handrail of balcony, make sure the solar panel facing outside; Use the solar hook Fastener(E) to stop the solar hook out from the handrail. (Tip: Carry and handle the heavy solar panel by two peoples and make sure all the fastener are fully secured)

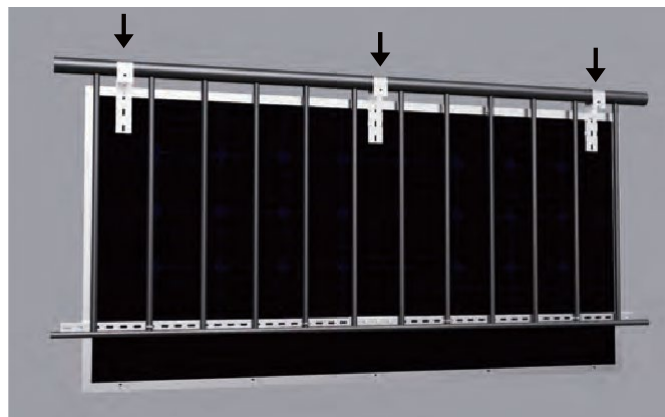

Step 5: Apply the insert of End Clamps (G) into the groove of mounting rail(A).Attaching to the solar panel, and lock the frame of solar panel with the mounting rail tightly.

Tip1: Use the right end clamp to measure the thickness of the solar panel (option for30 or 35mm)

Tip2: Both side of the panel must be locked tightly.

Tip3: Just stretch out your hand to do the job; Remain your body inside the balcony or ask license people to do the job.

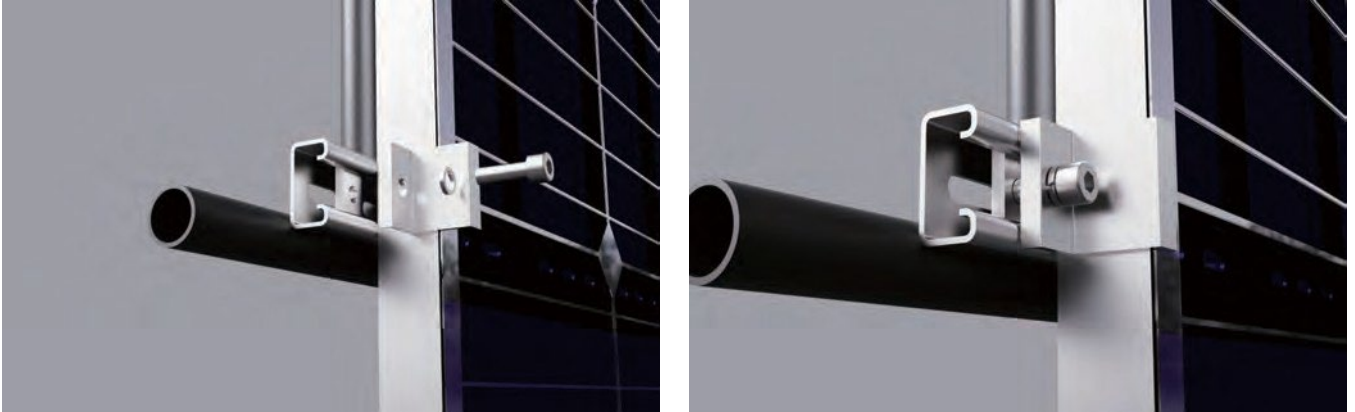

Step 6: Check all the screw & nuts again ,make sure that all the fastens are fully secured and thesolar panel is not moving left and right.

